

MC2845

FOR GENERAL SWITCHING APPLICATION
SILICON EPITAXIAL TYPE(SERIES TYPE)

DESCRIPTION

MC2845 is a super mini package plastic seal type silicon epitaxial type double diode, especially designed for general switching application.

Double and small pin capacitance(2pieces), suitable for protect circuit, bias circuit.

FEATURE

- Small pin capacitance
- Double and super mini package for mounting

APPLICATION

For general switching of audio machine, VCR.

OUTLINEDRAWING

Unit: mm

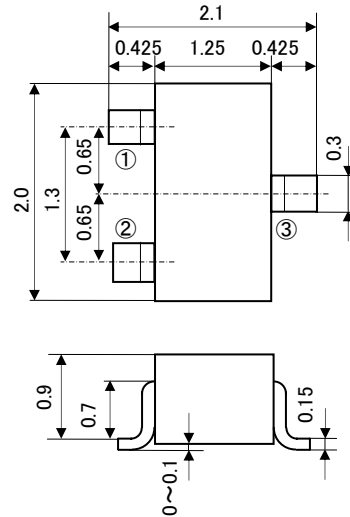

JEITA: SC-70

JEDEC: -

TERMINAL CONNECTER

①: CATHODE 2

②: ANODE 1

③: CATHODE 1+ ANODE 2

MAXIMUM RATINGS (Ta=25°C)

Symbol	Parameter	Ratings	Unit
V_{RM}	Peak reverse voltage	35	V
V_R	DC reverse voltage	30	V
I_{FSM}	Surge current (1 μ s)	4	A
I_{FM}	Peak forward current	300	mA
I_O	Average rectification current	100	mA
P_T	Total allowance dissipation (Ta=25°C)	150	mW
T_j	Junction temperature	+125	°C
Tstg	Storage temperature	-55~+125	°C

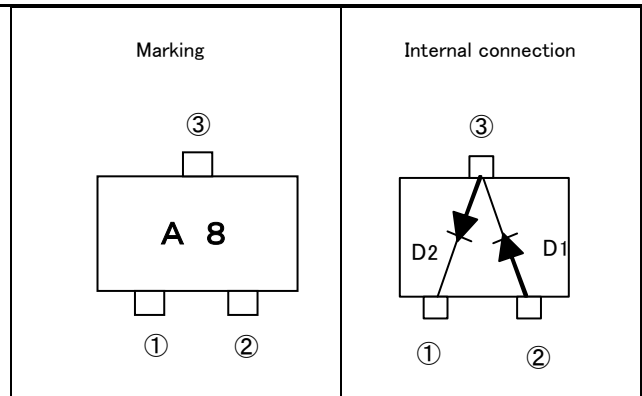

< SMALL-SIGNAL DIODE >

MC2845

FOR GENERAL SWITCHING APPLICATION
SILICON EPITAXIAL TYPE(SERIES TYPE)

ELECTRICAL CHARACTERISTICS ($T_a=25^\circ\text{C}$)

Parameter	Symbol	Test conditions	Limits			Unit	
			Min	Min	Min		
Forward voltage	V_{F1}	$I_F=10\text{mA}$	-	0.75	1.0	V	
	V_{F2}	$I_F=50\text{mA}$	-	0.85	1.2		
	V_{F3}	$I_F=100\text{mA}$	-	0.90	1.4		
Reverse current	I_R	$V_R=30\text{V}$	-	-	0.1	μA	
Pin capacitance	C_t	$V_R=0\text{V}, f=1\text{MHz}$	Tr1	-	6	-	pF
			Tr2	-	10	-	

TYPICAL CHARACTERISTICS

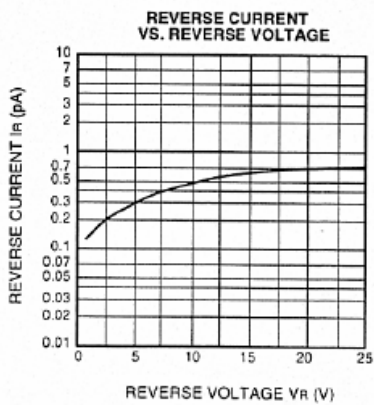
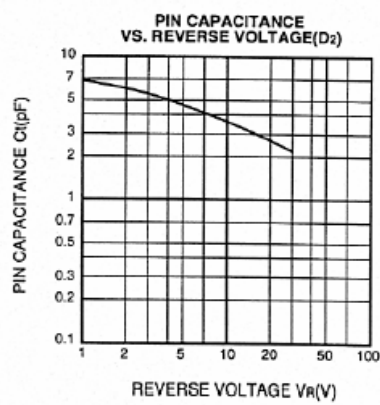
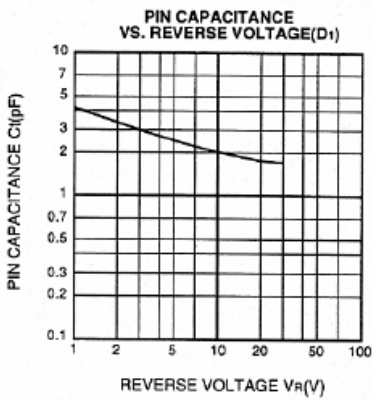
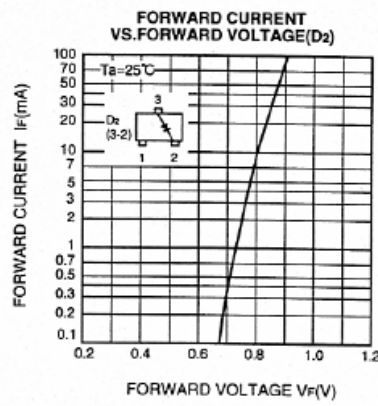
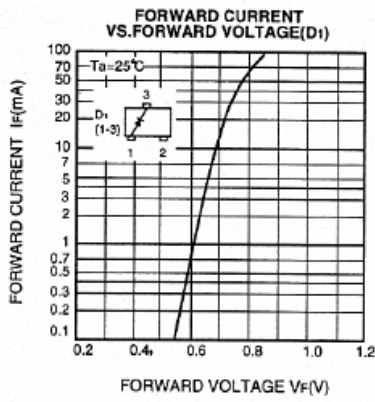



Marketing division, Marketing planning department

6-41 Tsukuba, Isahaya, Nagasaki, 854-0065 Japan

Keep safety first in your circuit designs!

•ISAHAYA Electronics Corporation puts the maximum effort into making semiconductor products better and more reliable, but there is always the possibility that trouble may occur with them. Trouble with semiconductors may lead to personal injury, fire or property damage. Remember to give due consideration to safety when making your circuit designs, with appropriate measures such as (1) placement of substitutive, auxiliary, (2) use of non-flammable material or (3) prevention against any malfunction or mishap.

Notes regarding these materials

- These materials are intended as a reference to our customers in the selection of the ISAHAYA products best suited to the customer's application; they don't convey any license under any intellectual property rights, or any other rights, belonging ISAHAYA or third party.
- ISAHAYA Electronics Corporation assumes no responsibility for any damage, or infringement of any third party's rights, originating in the use of any product data, diagrams, charts or circuit application examples contained in these materials.
- All information contained in these materials, including product data, diagrams and charts, represent information on products at the time of publication of these materials, and are subject to change by ISAHAYA Electronics Corporation without notice due to product improvements or other reasons. It is therefore recommended that customers contact ISAHAYA Electronics Corporation or an authorized ISAHAYA products distributor for the latest product information before purchasing product listed herein.
- ISAHAYA Electronics Corporation products are not designed or manufactured for use in a device or system that is used under circumstances in which human life is potentially at stake. Please contact ISAHAYA electronics corporation or an authorized ISAHAYA products distributor when considering the use of a product contained herein for any specific purposes, such as apparatus or systems for transportation, vehicular, medical, aerospace, nuclear, or undersea repeater use.
- The prior written approval of ISAHAYA Electronics Corporation is necessary to reprint or reproduce in whole or in part these materials.
- If these products or technologies are subject to the Japanese export control restrictions, they must be exported under a license from the Japanese government and cannot be imported into a country other than the approved destination. Any diversion or re-export contrary to the export control laws and regulations of Japan and/or the country of destination is prohibited.
- Please contact ISAHAYA Electronics Corporation or authorized ISAHAYA products distributor for further details on these materials or the products contained therein.